

HOZELOCK

2826

3in1

WATER BUTT PUMP

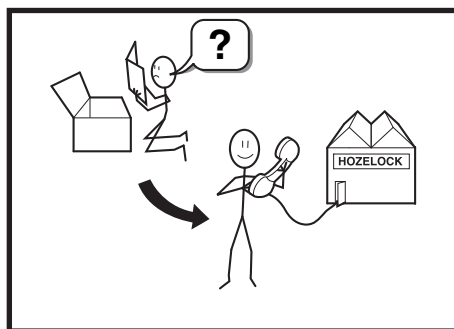
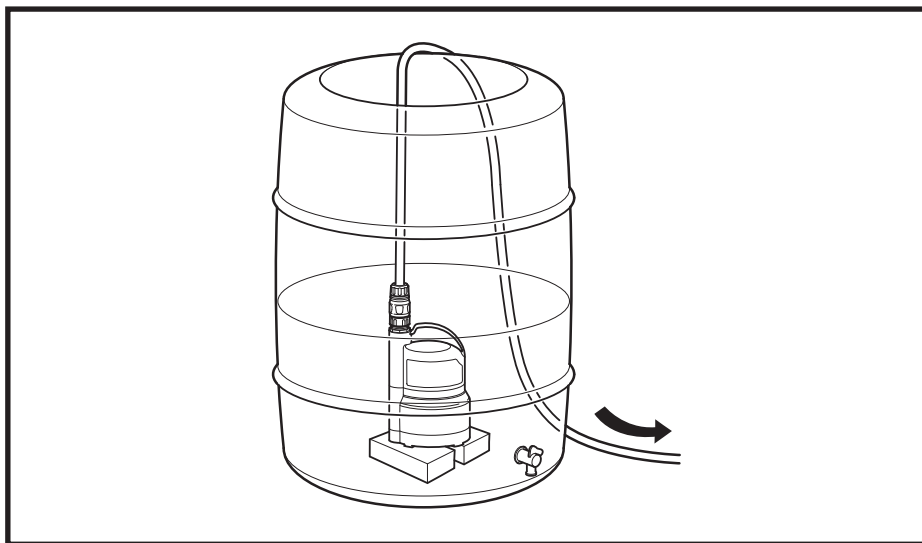

HOZELOCK

Hozelock Ltd.
Midpoint Park,
Birmingham B76 1AB. England
Tel: +44 (0) 121 313 1122
info@hozelock.com
www.hozelock.com

33725-001

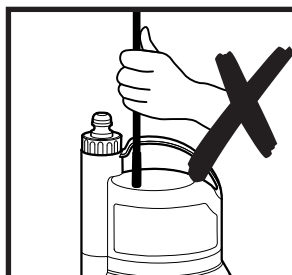

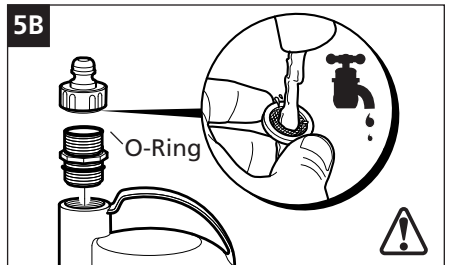
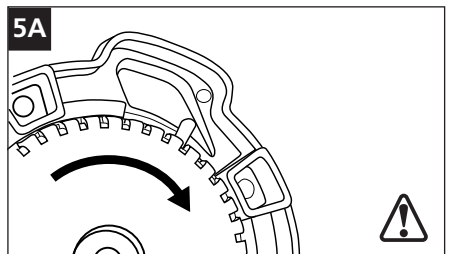
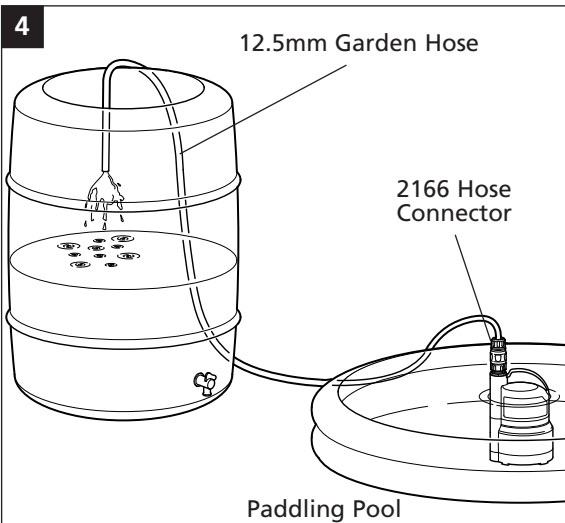
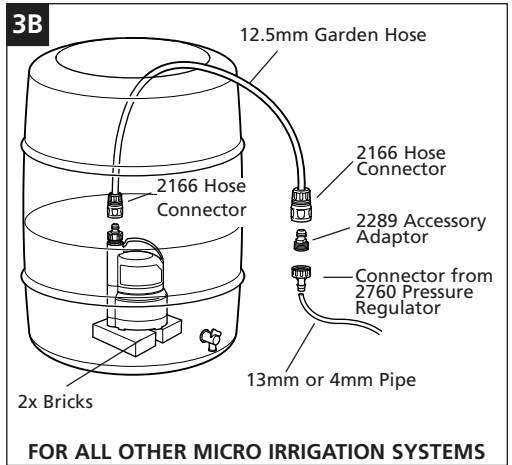
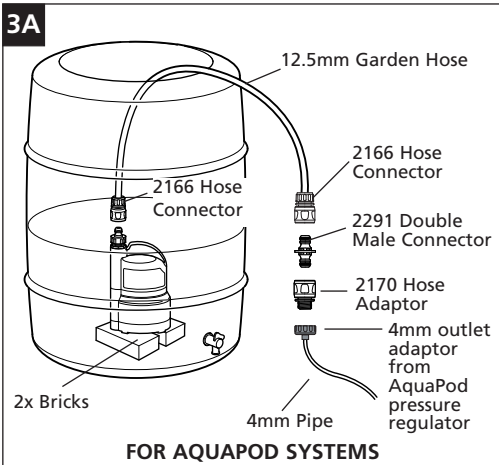
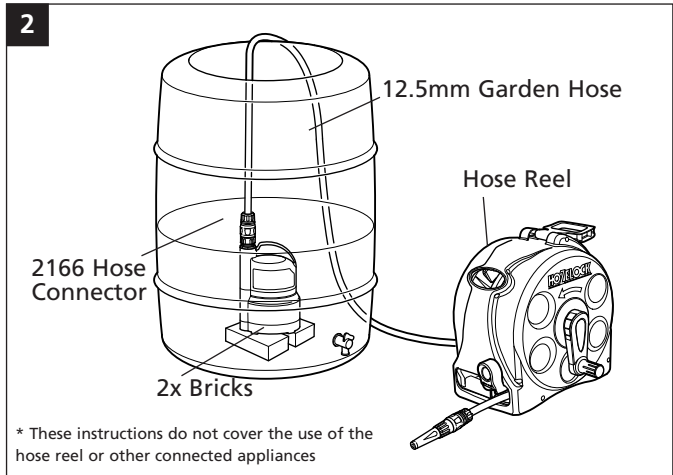
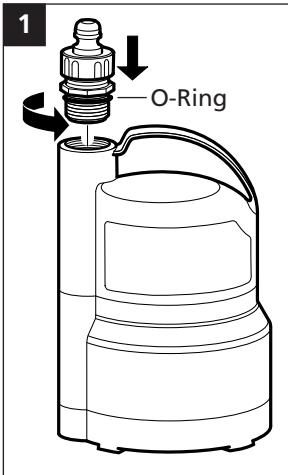

General Safety

Warning : Read this manual carefully before installing this pump.

 This sign warns the user that failure to follow an instruction may damage the pump or the system

 This sign warns the user of important electrical safety information.

 Carefully store this manual. If problems arise contact Hozelock customer services.

Every Hozelock Water Butt Pump is carefully tested and packed during assembly.

On receipt, check that the pump has not been damaged during transport. If the pump is damaged, do not use, and contact Hozelock customer services.

Electrical Safety

Check that the voltage and frequency of pump shown on the rating label corresponds to those available on the mains.

 **ELECTRICAL INSTALLATION:**

 A 10MA OR 30MA RESIDUAL CURRENT DEVICE (RCD) MUST BE FITTED TO THE MAINS SUPPLY.

 PROTECT THE PLUG AND THE POWER CABLE FROM HEAT, OIL AND SHARP EDGES.

 DO NOT OPERATE THE PUMP IF IT HAS A DAMAGED POWER CORD OR PLUG. IF THE POWER CORD OR PLUG IS DAMAGED, IT MUST BE REPLACED BY A SUITABLY QUALIFIED PERSON IN ORDER TO AVOID A HAZARD.

 MAKE SURE THAT ELECTRIC

CONNECTIONS ARE PROTECTED FROM WATER & SPLASHES

 THE POWER CABLE SHOULD HAVE A MINIMUM OF 3 CORE 0.75MM² SECTION EQUIVALENT TO THAT OF H05 RN-F. TO MAKE SURE THE PLUG IS PROTECTED FROM ANY SPLASHES. USE THE 10M CABLE SUPPLIED TO CONNECT AS FAR AWAY FROM THE PUMP AS POSSIBLE

 BEFORE USING THE PUMP, ALWAYS INSPECT IT VISUALLY (ESPECIALLY THE POWER CABLE AND THE PLUG). DO NOT USE THE PUMP IF IT IS DAMAGED.

 NEVER USE THE POWER CABLE TO LIFT THE PUMP

Plug Wiring

(UK and Ireland)

This product is fitted with a BS 1363 plug with a 5 amp ASTA approved fuse. If you have to replace the fuse, only those that are ASTA or BSI approved to BS 1362 and with a rated current of 5 amps should be used. If there is a fuse cover fitted, this cover must be refitted after changing the fuse. If the fuse cover is lost or damaged, the plug must not be used. Spare fuse holders and fuses are available from electrical outlets.

If the power supply cord or plug becomes damaged in any way, it should be replaced by a suitably qualified person. A replacement plug should be wired according to the following instructions.

IMPORTANT: This appliance must be earthed. As the colours of the wires in

the mains lead of this product may not correspond with the colours or markings identifying the terminals in your plug, you should proceed as follows:



The wire that is coloured green & yellow must be connected to the EARTH terminal in the plug which may be marked with the letter E or coloured green or green & yellow or marked with the earth symbol (⏚).



The wire that is coloured blue must be connected to the NEUTRAL terminal which may be marked with the letter N or coloured blue or black.

The wire that is coloured brown must be connected to the LIVE terminal which may be marked with the letter L or coloured brown or red.

If in doubt, contact a qualified electrician.

Limitations

This pump can be used to:

-  1. Drive sprayguns and micro irrigation systems.
-  2. Move rainwater and domestic waste water (bath water).
-  3. Remove water from paddling pools and flooded rooms.

The pump can be completely or partially submersed and used to transfer clean or moderately dirty fluids.

 This pump should not be used with swimming pools where

people can become immersed in water.

 This pump should not be used for table fountains / aquariums / fountains / filters for fish ponds / waterfalls.

 The pump cannot be used for sea water & inflammable, corrosive, explosive or dangerous liquids. The pump must never be run dry.

 The pump must not be used when people are in the water.

 The sprayer must not be used when people are in the water.

 Do not spray the outlet towards people or animals.

 This appliance is not intended for use by persons (including children) with reduced physical, sensory or mental capabilities, or lack of experience and knowledge, unless they have been given supervision or instruction concerning use of the appliance by a person responsible for their safety

Installation

Before installation, and whenever you are handling the pump, always disconnect from the electrical supply.

 To prevent injury, never put your fingers into the mouth of the pump.

- Screw the threaded fitting supplied onto the pump. (see Fig. 1)
- Use the handle provided to carry or lift the pump.
- When used with a water butt for the first time, ensure the water butt is emptied and cleaned of all sediment, leaves and accumulated debris.

- To avoid the pump clogging - the pump should not be placed on the bottom of the water butt, this can be achieved by either suspending the pump from a rope attached to the handle, or by placing the pump on 2 bricks (see Fig. 2).
- The pump has a self priming vent to remove any trapped air. The priming process can take up to 5 minutes. For faster priming lower the pump in to the water without the hose connected, and connect the hose after a few seconds once the air has escaped.

TO CONNECT TO AN IRRIGATION SYSTEM:

- For use with hoses and hose reels (see Fig. 2) add a 2166 hose connector (available separately) and pass hose out through hole in lid of tank.
- For use with micro irrigation system - **Do not use with a pressure regulator** (see Fig. 3) Remove inlet from pressure regulator and attach directly to the hose outside of the water butt using a 2166 hose connector and a 2289 accessory adaptor (both available separately).

TO DRAIN WATER:

- (see Fig. 4) add a 2166 hose connector (available separately) and place the end of hose in a suitably sized and positioned container.

Overload protection

- The Hozelock Water Butt Pump has a built in thermal protection switch. The pump stops if an overload condition occurs. The motor restarts automatically after it has cooled

down.

To start the pump

- Insert the pump into a 220-240v A/C socket.

Maintenance

In ordinary conditions the Water Butt Pump does not require any maintenance, however occasionally it will be necessary to clean the two filters and the inlet.



Make sure that the pump is disconnected from the electric power supply before performing any maintenance.



- To clean the coarse inlet filter, remove filter cover on base of pump by twisting clockwise (see Fig 5A). Remove filter sponge and rinse in clean water. Replace sponge and re assemble filter cover.



- To clean the fine outlet filter, remove tap connector on outlet of pump, remove fine filter from inside the tap connector and rinse in clean water (see Fig 5B). Replace fine filter in tap connector and re-assemble. (NB – This filter is designed to protect your Hozelock products from damage due to the use of dirty water. It is essential to use with micro irrigation, AquaPod, & all Sprinklers. It is optional with sprayguns , nozzles & lances).

Pump storage

Store the pump in a dry place and protect from frost.

Troubleshooting

Problem	Possible Cause	Remedy
The pump does not pump water, & the motor is not running	No electricity	Check that the electricity supply is turned on & that the pump is correctly plugged in.
	Plug inserted incorrectly.	
	Circuit breaker is tripped.	Reset electricity supply. If the circuit breaker trips once more contact a specialised electrician
	Blocked impeller	Unplug from the electricity supply and remove possible obstructions from the impeller
	Damaged motor	Contact Hozelock customer services for assistance.
	Pump has overheated	Pump contains thermal protection - check if pump case is hot, and if so, allow to cool
The pump supplies a limited amount of water or the pump does not pump water, and the motor is running	Pump full of air	Unplug from the electricity supply and disconnect outlet hose, submerge in water and allow all air to escape, reconnect hose and power.
	Obstructed inlet	Remove inlet strainer and foam, clean and replace.
	Obstructed pipe/outlet	Remove obstructions or kinks and clean outlet filter.
	Worn impeller	Contact Hozelock customer services for assistance.
The pump works only intermittently	Solid particles prevent the free rotation of the impeller	Clean inlet and impeller.
	The temperature of the fluid is too high	 Only use with fluids below 35°C
	Fluid too dirty.	Empty and clean the water butt, refill with fresh rain/ tap water
	Faulty motor	Contact Hozelock customer services for assistance.

cont.

Jet of water sprays out	Air vent hole operating	This is not a problem. The hole is to allow air to exit the pump to make priming the pump easier.
Water is leaking from the outlet of the pump	Inlet assembly not tight enough	Tighten
	Hozelock connector not correctly attached	Re-attach Hozelock connector

Pump Specification

Max Pumping Height, H_{max} : 11m

Maximum Suction Height : 8m

Maximum Flow Rate, Q_{max} : 2200 lph



Hozelock Ltd.
Midpoint Park,
Birmingham B76 1AB. England
Tel: +44 (0) 121 313 1122
info@hazelock.com
www.hazelock.com
33725-001



Do not dispose of electrical appliances as unsorted municipal waste, use separate collection facilities. Contact you local government for information regarding the collection systems available.
If electrical appliances are disposed of in landfills or dumps, hazardous substances can leak into the groundwater and get into the food chain, damaging your health and well-being.
When replacing old appliances with new ones, the retailer is legally obligated to take back your old appliance for disposals at least free of charge.